

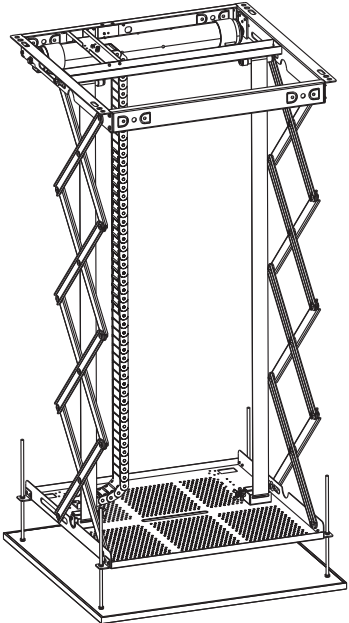

Recessed-Ceiling Motorized Projector Lift

Applicable Model	Maximum weight
GPCK-ME500P	25KG
GPCK-ME1000P	25KG
GPCK-ME2000P	25KG
GPCK-ME3000P	25KG



Please read before installation:
Thank you for purchasing this product.
Please read the instruction manual carefully to ensure this projector lift is suitable for your installation environment.

Cautious



Warnings

This product should only be installed by a qualified technician.
Please review the manual carefully to ensure it is properly installed and to avoid injury.
The ceiling used must have a minimum load bearing of 25KG.



Caution

For projector lift assembly only



Do not take apart

Please do not take apart the accessories of mounting bracket

Guangzhou Grandview Creative Technology Co., Ltd

Add: No.1 Building of No.43 South International Trade Avenue,
Hualong Town, Panyu District, Guangzhou China.
Tel: +8620-8489-9499 Fax: +8620-8480-5299
Http://www.grandviewscreen.com



WARNING: Important safety instructions.
It is important for the safety of persons to follow these instructions. Save these instructions.

It is important for the safety of persons to follow these instructions.

- For models with fixed control, do not allow children to play with fixed controls. Keep remote controls away from children.
- Frequently examine the installation for imbalance and signs of wear or damage to cables and springs. Do not use if repair or adjustment is necessary.
- Do not stand below the product when it is working.

WARNING: Important safety instructions.
Follow all instructions, since incorrect installation can lead to severe injury.

- Before installing the drive, remove any unnecessary cords and disable any equipment not needed for powered operation.
- For models with wall switch fixed control, the actuating member of a biased-off switch is to be located within direct sight of the driven part but away from moving parts. It is to be installed at a minimum height of 1.5 m.
- when projector lift completely opened, the moving part at least 2.5 m above floor level or othe access level.

Trouble Shooting

The Grandview GPCK-ME is designed for many years of use. Problems are usually caused by small issues or improper use. If there problems please refer to the follow trouble shooting list. If problems persist, please contact the authorized dealer .

	Causes	Solution
The projector lift can not funtion properly after installation.	Power cable is no connected	Refering to the user manual and connect the power cable
	Outlet does not have power	Verify the wall outlet if it has sufficient voltage to support the operation.
	Control switches have not been properly positioned	Refering to manual guide and make sure the control switches are well positioned (up, down, stop)

Limit three year warranty only

Grandview provided limit three year warranty on motorized projector lift products. Grandview's sole obligation under this warranty shall be to repair or to replace the defective part of the merchandise if the projector lift has been operated properly. This warranty does not apply to apparatus showing evidence of misuse, abuse or accidental damage, or which has been installed or operated improperly.

Maintenance and Adjustment

1. Please fully retract the project lift after used to avoid the projector exposing to the air and dust, which may cause the adverse effect on the imaging.
2. Do not roll and retract the projector lift continuously over 4 minutes to avoid overheating. If the motor continuously work excess 4 minutes, it will be thermally protected and stop working until it has cooled to a safe temperature before it will start operating again.
3. Lubrication is not necessary for the motor. The drop and retraction limits have been properly adjusted at the factory (Contact the qualified technician or dealer for the adjustment.)
4. Please clean the projector lift with the dilute detergent slightly and dry it up with the soft cloth. Use the banister brush to clean the gap.
5. The adjustment of the full retraction position (up limit) and full drop position (down limit).

Full drop position (Down limit) adjustment, press "down" on the remote control to lower the project lift, insert the accessory tool into the down limit switch, turning the socket clockwise will stop the projector lift closer to the ceiling, turning the socket counter-clockwise will cause the projector lift to stop at a lower point.

 We strongly suggest that the up limit should not be adjusted by the user in order to avoid the damages that cause by inappropriate operation.

Full retraction position (Up limit), press "up" on the remote control to raise the project lift, when the project lift fully retracted and reached the ceiling level, insert the accessory tool into the up limit switch, turning the socket clockwise will create a lower closed position, turning the socket counter-clockwise will create a higher, or more fully closed position.

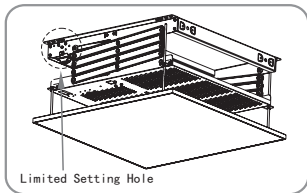

Figure 31

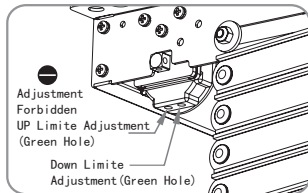

Figure 32

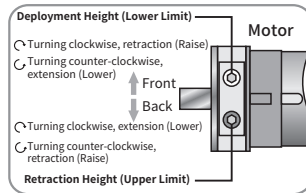



Figure 33

-  **Warning**
1. Please be careful during adjusting, over up limit adjusting may result in damage to the woven belt and the motor.
 2. During the Lowering Limit adjusting, make sure there are more than one and half loops of the woven belt around the roller to avoid it from breaking off. 3. Check for satisfactory condition by operating until few times.

How to Check whether Over up limit adjusting (Retraction)

- A. Check the connecting rod on the both end, and see whether no gap between two Rod;
- B. The bottom plate can't work.

Caution

Warning: In order to minimize the risk of fire or electric shock, do not expose this apparatus to rain or moisture.

1. Please read the instructions carefully before installation to avoid the damage of the product which causing by inappropriate installation or operation.
2. Please keep the GPCK-ME away from the hot sources, such as radiator, heating machine, fireplace and other devices which contain the loudspeaker.
3. This apparatus must be earthed.
4. Only the accessories that provided by the authorized suppliers should be used.
5. Unplug the power cord from the wall outlet during stormy weather or if the apparatus is not used for several days.
6. Servicing should be done by qualified service personnel.
7. Please do not install this apparatus in the humid area.
8. The apparatus is not disconnected from the AC power source as long as it is connected to the wall outlet, even if the apparatus itself has been turned off.
9. Use the approved Power Cord (3-core mains lead) / Appliance Connector / Plug with earthing-contacts that conforms to the safety regulations of each country if applicable.
10. Use the Power Cord (3-core mains lead) / Appliance Connector / Plug conforming to the proper ratings (Voltage, Ampere). If you have questions on the use of the above Power Cord / Appliance Connector / Plug, please consult a qualified service personnel.
11. During the installation, incorporate a readily accessible disconnect device in the fixed wiring, or connect the power plug to an easily accessible socket-outlet near the apparatus. If a fault occurs during operation of the unit, operate the disconnect device to switch the power supply off, or disconnect the power plug.
12. The ceiling or wall used for installation must be secure enough; load-bearing capacity must be more than 4 times of the total weight of this apparatus and the projector in order to prevent the apparatus from falling.

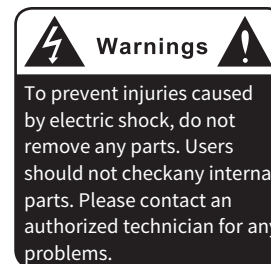

Please notice the non-insulated voltage of the spare parts to prevent from electric dangerous.



Please operate according to the instruction manual.

Cleaning

Please clean the projector and projector lift at the same time.

Cautions

Please comply the following contents for installation and use

- Please do not shake the projector lift
- Please do not lift up the projector lift

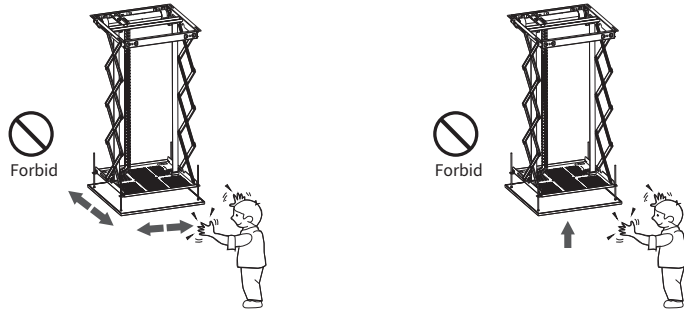

Cautions for Location

- Please keep away from hot resources, dirty, high temperature and high humidity.
- Do not use the projector off the large wind.

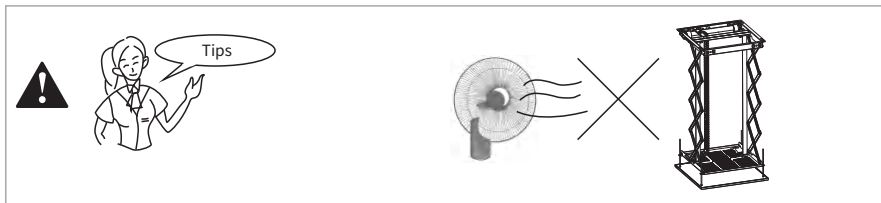

Cautions for Repairing

- Please do not take apart the screws of the projector lift; if this product needs to be repaired, please contact our company or dealers.



Instruction

*In-line Switch with Easy and Steady Operation(Optional), Standard with power plug interface (no power cable and plug)

*External IR/RF remote control(Optional,External Slot in the back of Lift)(Figure 18 -20)

1.In-Line Switch(Figure25)

- (1)Before use the lift, please ensure the lift has been well installed and the decorative ceiling board can retract smoothly without getting stuck by ceiling.
- (2)Connect Power(Rated Voltage)
- (3) Press the "Up"and "Down" buttons to lower and Retract the Lift.Press the Stop "0" at any required postion.

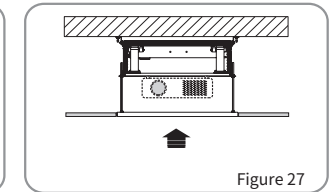
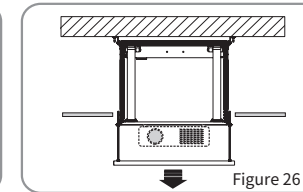
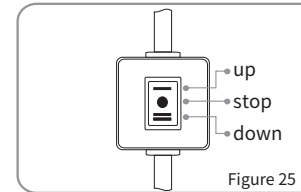

2.External IR/RF remote control(Optional)

Please purchase Grandview 3th Generation External IR/RF remote control(Optional) when RS232/485 control required.

- (1)Please fix the external Receiver box on the ceiling and ensure close to the lift.
- (2) Connecting the receiver box and lift with a Quad Cable(Cable Dia must bigger than $4 \times 0.75\text{mm}^2$,refer to Figure 28)
- (3)For the instruction manual of Receiver box, please refer to single Manual Paper.

Model of External RF remote controller:

External IR Remote Control(3th Generation),Model No.1GD-IRAnIII

External RF Remote Control(3th Generation),Model No.1GD-868MnIII

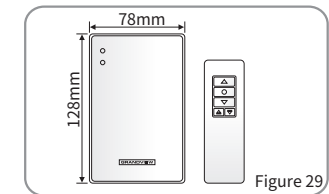
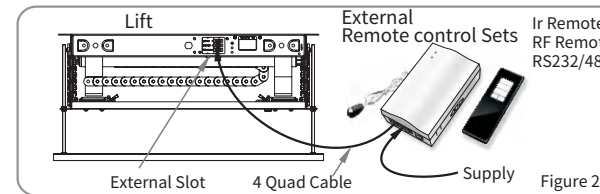

3. Circuit diagram

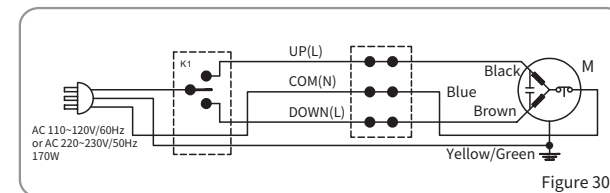

Installation

12. Before contacting the power cable of projector lift, please take out the wire cover in the back of lift (Figure 18). Then choose the control option and connect the controlling wires to terminals (Figure 19-20). For humanization, link the power after fixing the controller of cables on a place for easy using.

Notes: Ensure the supply voltage is matching the normal working voltage of this product, and the recommended power is 2 times more than the sum of lift's power and projector's power. It will be dangerous and will lead to damage of product in case using mismatching power supply.

Caution: The electrical work should only be installed by a qualified electrician or it may cause product damage even personal casualty.

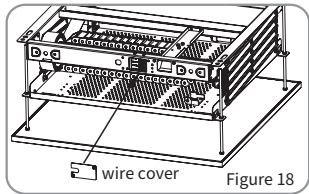

Figure 18

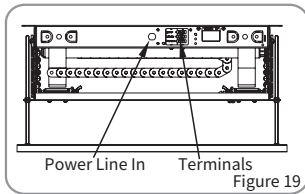

Figure 19

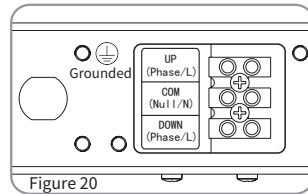

Figure 20

13. Please adjust motorized lift to keep balance in need, if there is unbalanced changes occur in controlling up and down several times after power on.
14. Adjust the height of decorative ceiling plate depended on the actual ceiling height, and twist setscrew nut on the 200mm long screws assembled in the four corners of decorative ceiling plate. The max height is about 200mm (Figure 22). Please tighten screws to avoid looseness.

Please cut short the standard 200mm long screws or use a shorter screw once the distance of decorative ceiling plate and multi-orifice plate is too close.

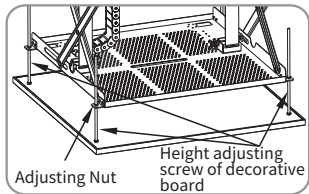

Figure 21

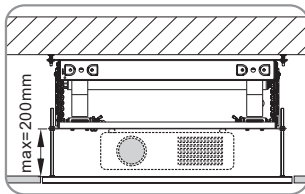

Figure 22

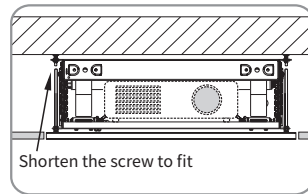

Figure 23

15. (Figure 24) Trim the ceiling plate to the appropriate size and assemble it back into the ceiling grid. The suggested distance of ceiling plate to the lift's decorative ceiling plate is about 5mm. Please use the same way to adjust the ceiling plate in case the height of decorative plate is not the same as the ceiling plate around.

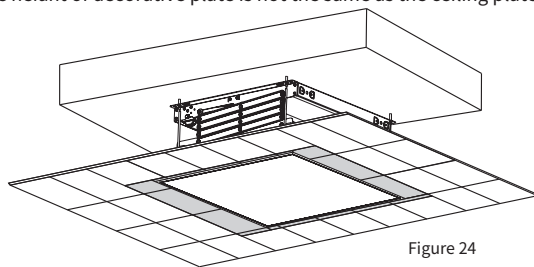

Figure 24

Accessories

- M4 Hexagonal Adjuster (1pc)
- M5, M4, M3x20mm Screw (each 4pcs)
- Rubber Washer $\Phi 16 \times \Phi 5.2 \times 10 \text{mm}$ (4pcs)



- Ceiling punching positioning paperboard

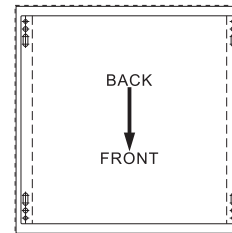

- Long ribbon (3 pcs)
- 6P-4 power wire clip (1 pc)
- Product certificate (1 pc)
- Users manual (1 pc)
- Screw M6x255mm (4 pcs)
- M6 nut (8 pcs)

Optional accessories

- Installation Bar (4pcs)

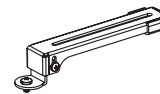

- External remote control kit (with RS 232/485 control function)

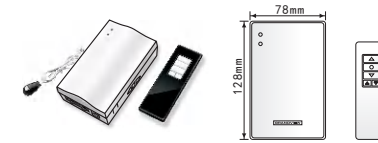

External IR remote control set (3rd generation), model: 1GD-IRAnII
External RF remote control set (3rd generation), model: 1GD-868MnII

- M10x500 Threaded Rod (4pcs)
- M10 Nut, Washer (16pcs/each)
- Hanger (4pcs)



- In line switch (1set)

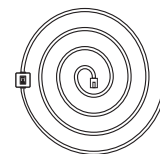

- Cables

- RCA coaxial video cable
- VGA extended cable
- HDMI High definition extended cable
- Alternating current extended cable

Construction for Projector Lift

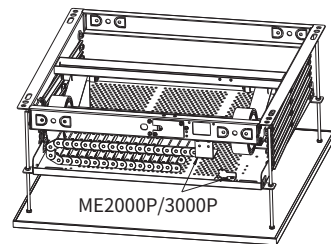
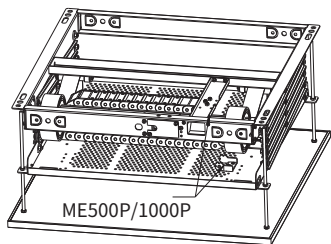
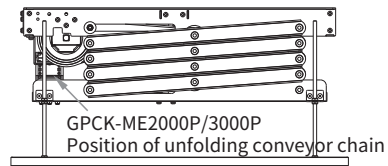
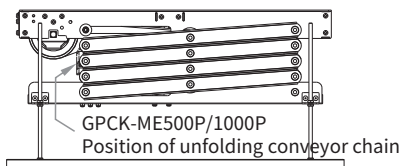
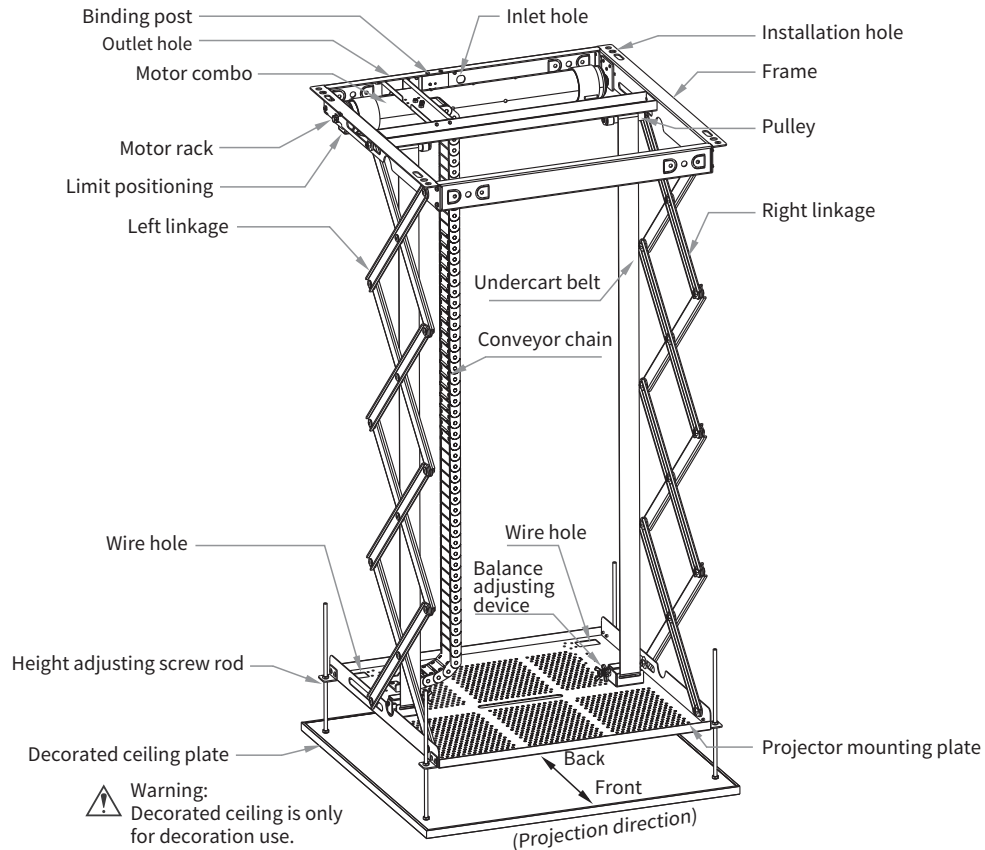

Installation

8. Choose front or inverted projection direction as required and install the projector accordingly.

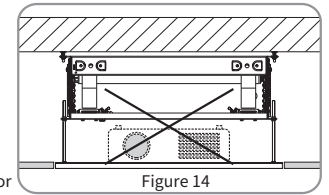
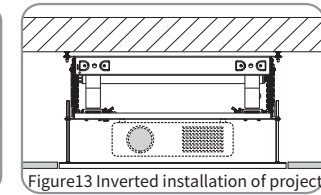
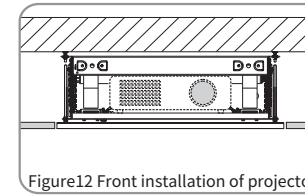

Caution: Decorative ceiling plate can not bear any weights and must be fixed onto the multiorifice plate by screws, or it may cause product damage even personal casualty.

※ Please choose front or inverted installation of projector accordingly. For front installation, it is applicable to low ceiling location and requires more than 20mm gap between the projector and lift which ensures function well of projector lift.

9. Fasten screws to fix the projector onto the multiorifice plate as projector's slip device.

※ This multiorifice plate is universally applicable for most kinds of projectors. Please use multifunctional arms in case of not corresponding mounting holes between projector and the multiorifice plate. There are 4 units of multifunctional arms in one package and will provide you a flexible adjustment installation.

10. Find the signal and power cables in the back of projector then contact the cables through the square opening at the back bottom of multiorifice plate.

11. The installation board may be unbalanced since the difference of woven belt's tightness or the not centric barycenter of projector. To keep the installation board balance please adjust the length of woven belt. (Figure 15)

- Left height adjustment (Figure 16), firstly unscrew the left adjusted nut from middle to left, then you can release or tighten belt by turning left screw. Turning clockwise to release belt and would lower height of left side. Inversely, turning counterclockwise to tighten belt and upper height of left side.

- Right height adjustment (Figure 17), firstly unscrew the right adjusted nut from middle to left, then you can release or tighten belt by turning right screw. Turning clockwise to release belt and would lower height of right side. Inversely, turning counterclockwise to tighten belt and upper height of right side.

- Please make sure the adjusted nut after adjustment.

※ The woven belt can be adjusted within 20mm, keep lateral balance by adjusting both sides woven belt.

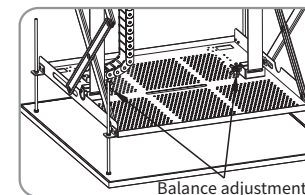

Figure 15

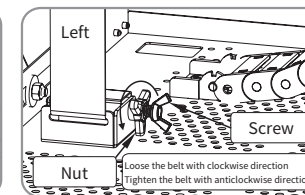

Figure 16

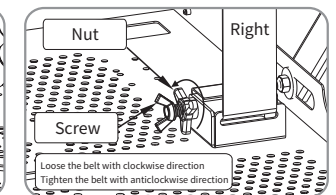

Figure 17

Installation

5. Figure 8, Add the M8 Screw to fasten the mount bracket.

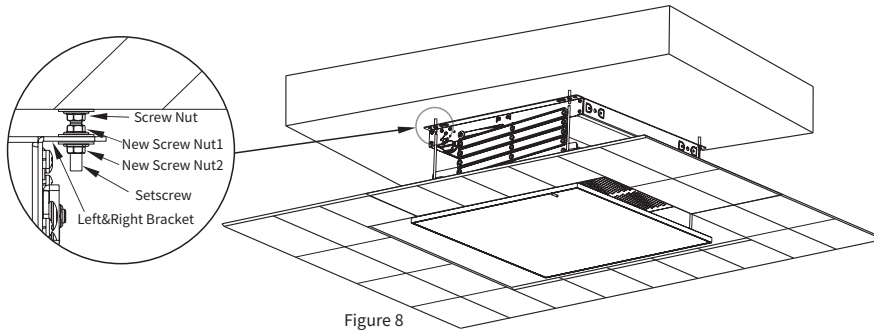

Figure 8

6. Check about the balance of projector lift with Levelling rod. If not in balance, please make a micro adjustment of screw, then remember to fasten the screw when it's done. Attention! Do check the balance before installation, in case it may affect further use. Also, it may cause product damage.

7. Open the cover plate, then put the power cord and Signal wire into the storage. Do make sure the cover plate is fixed. (Figure 9 to 10)

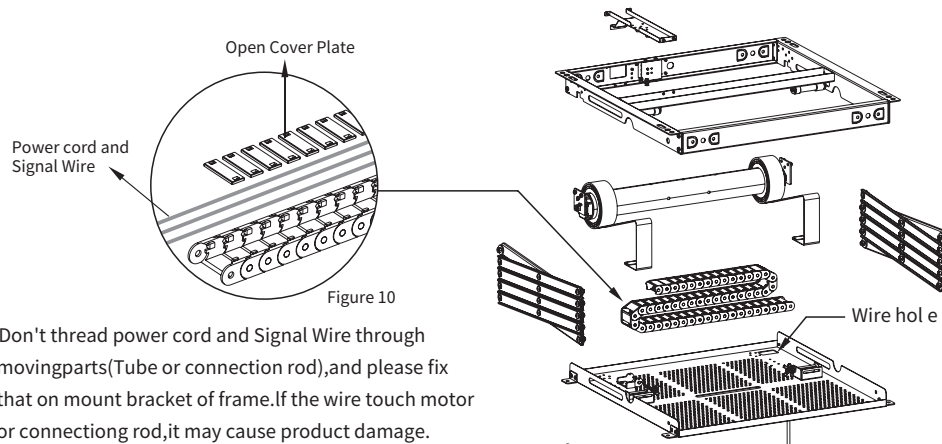

Figure 10

※ Don't thread power cord and Signal Wire through moving parts (Tube or connection rod), and please fix that on the mount bracket of the frame. If the wire touches the motor or connecting rod, it may cause product damage.

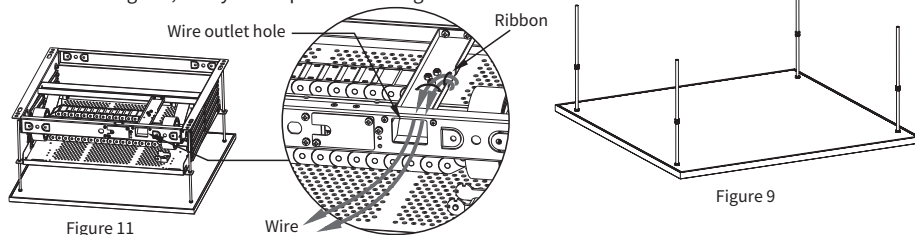
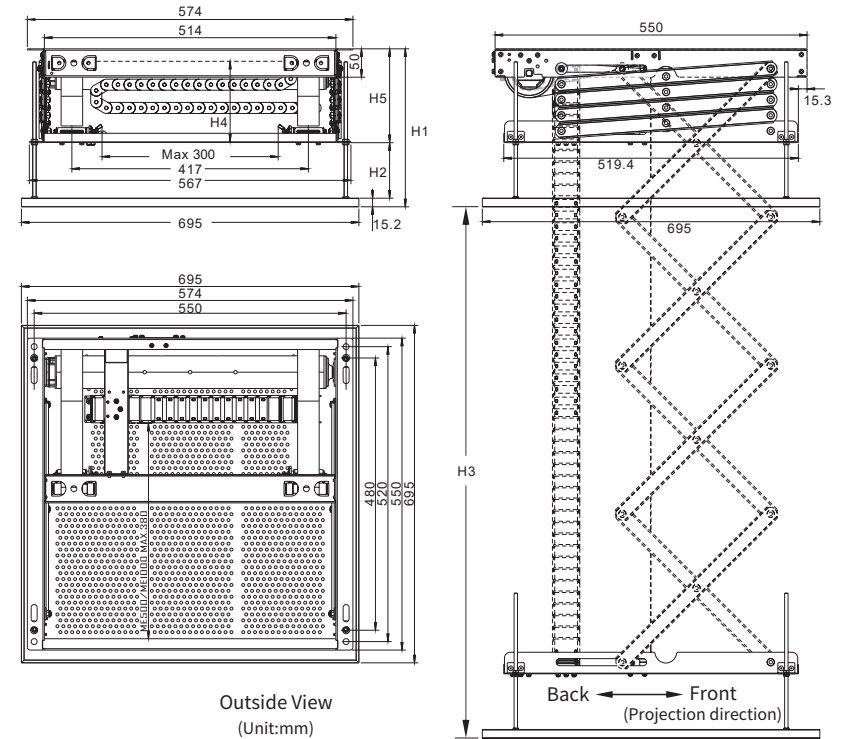

Figure 11

Figure 9

Specification



Outside View
(Unit:mm)

Specifications (Unit:mm)

Model	Retraction Height(H3)	Overall Height(H1)	Frame Height(H5)	Suitable projector size(H4)	Maximum weight(KG)	Suitable projector sizes	
GPCK-ME500P	0-500	135	110	75	25KG	Upright: W300 x D340 x H4 or: W460 x D240 x H4	Inverted: W600 x D600 x H240
GPCK-ME1000P	0-1000	190	165	130	25KG		
GPCK-ME2000P	0-2000	300	275	240	25KG	Upright: W300 x D440 x (H4-60) or: W460 x D240 x H4	
GPCK-ME3000P	0-3000	410	385	350	25KG		

Attention:

1. Overall Height (H1) means the distance from decorated ceiling plate to projector mounting plate. (H2=10mm)
2. Can adjust the H2 from Minimum 10mm to Maximum 200mm.

If projector inverted and its height over 200mm, can replace with 4 pieces M6 screw for higher H2 requirement.

3. The suggested opening ceiling dimension is 700x700mm or 705 x 705mm.

Electric parameter:

Voltage :AC 110V~120V/60Hz Or AC 220V~230V/50Hz, Currents:1.4A /0.74A

Power:170W, Motor:20Nm/17PRM/170W

Instruction

This projector lift needs to be recessed into the ceiling, and this instruction shows us the grille-ceiling as example. Please install the projector lift according to different application. The projector lift needs to be recessed at the best viewing angle in order to improve the image. Take out all the parts from the packaging and follow the accessories guideline to ensure you have all parts.

※ Please kindly read the instruction manual before installation for safety consideration, and choose the best installation method according to your site situation.

Below use grille-ceiling as example for instruction steps

1. Choose a position according to the required space, and then take apart the ceiling (Figure 1). Please measure the distance H between roof and ceiling surface correctly (Figure 2)

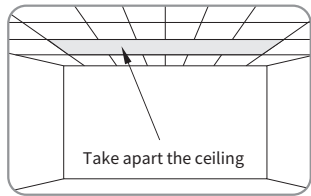

Figure 1

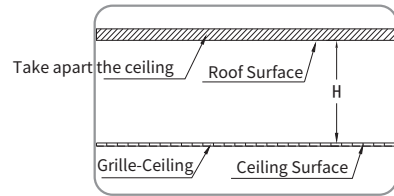

Figure 2

2. Pls choose the corresponding installation method according to the product height H1 and the distance between Roof Surface to Ceiling Surface H.

A. If $H < H1$ (Supposed it's Maximum H2), can install project lift on the Concreted-Ceiling directly Check Figure 3.

B. If $H > H1$ (Supposed it's Maximum H2), need lengthening bar (Optional accessories) to install Check Figure 4.

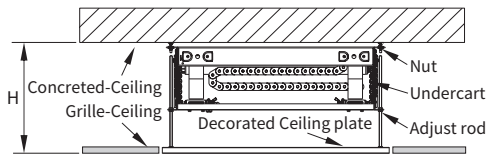

Figure 3 Standard ceiling installation

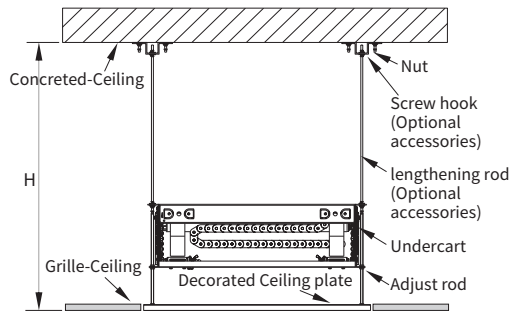

Figure 4 High Ceiling

Installation

3. Please stick the locating cardboard on the ceiling, then drill the ceiling by the guide hole of the cardboard. Then mount the lift and fasten by included M8X80 anchor screws, make sure the lift is fixed.

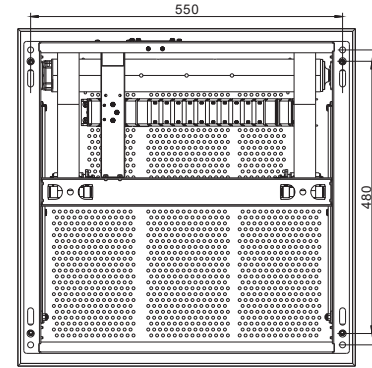

Figure 5 Distance of Installation Hole

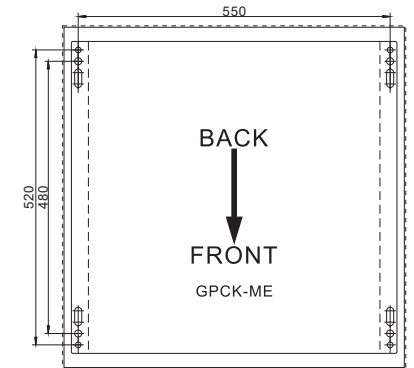

Figure 6 Locating Cardboard (For Drilling hole only)

4. Install the projector lift and fasten. (Figure 7)

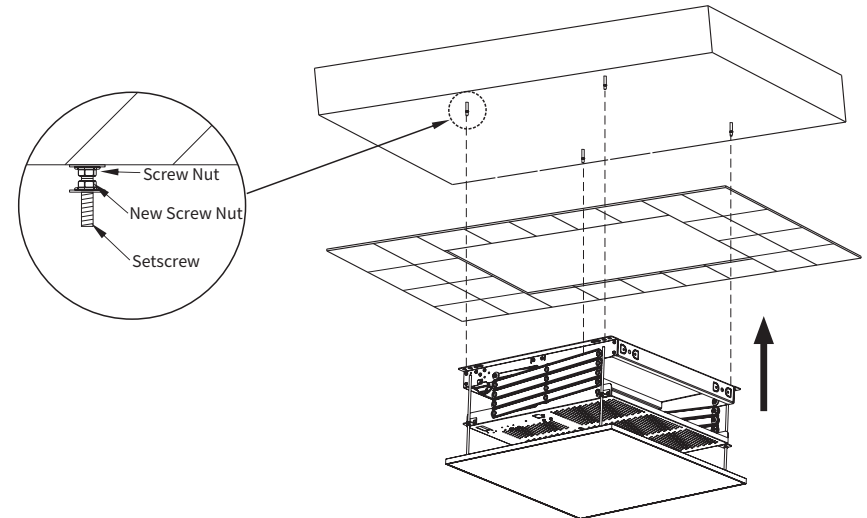

Figure 7