

C. Control via Dry Contact, RS485, RS232, or DC12V Trigger:

Pin Number	1	2	3	4	5	6	7	8
Function	RS485-B RS232-GND	RS485-A RS232-TXD	STOP	UP	DOWN	12V+	12V-	Common Lin

Connection diagram

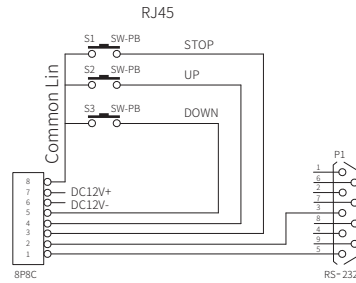
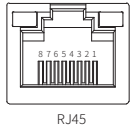

RS485 / RS232 Port Configuration:

- Data Bits: 8
- Start Bit: 1
- Stop Bit: 1
- Baud Rate: 2400
- UP: FFEFFFFFFF
- STOP: FFEFFFFFFF
- DOWN: FFEFFFFFFF
- Some central control systems may require setting address code: FFEFFFFFFF
- Learning address command: FFXXXX XAA (XXX represents any hexadecimal characters except E and 5)

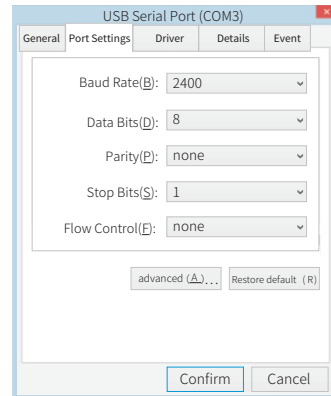

Notes:

- If the screen cannot be controlled via RS232 or RS485, swap the two control wires. The circuit resistance should be less than 20Ω.
- Do not route signal cables alongside strong electromagnetic interference sources.
- Serial port settings: 2400 bps, no parity, 8 data bits, 1 stop bit. Each command must be sent twice in succession.

Important Note:

- To ensure the accuracy and safety of the screen's position, during the adjustment process, always rotate the motor adjustment knob half a turn and then move the screen up and down to check if the position moves correctly!
- When adjusting the lower limit (fully extended screen), make only small adjustments. Over-adjustment may damage the screen. Ensure that the screen has at least 1.2 full rotations on the tube to prevent damage.
- Screen electrical specifications: Voltage AC220-240V, frequency 50-60Hz, power 45W.

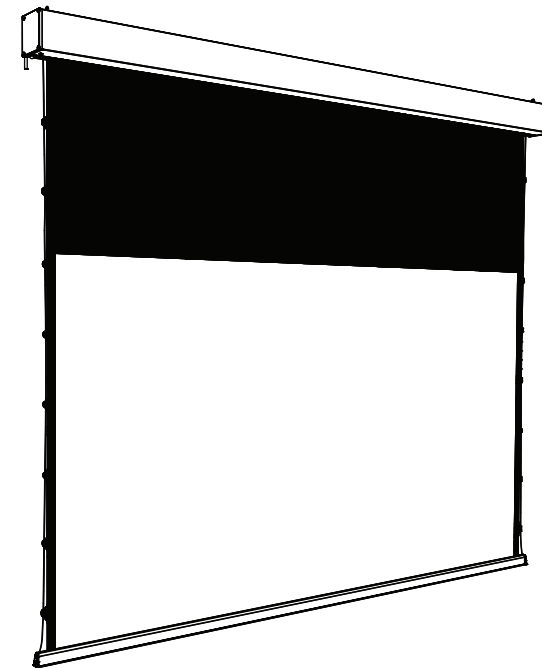





Important Notes

- The ceiling or wall where the screen is installed must be strong enough to support the screen's weight to avoid accidents.
- If the screen's outer frame affects the projection quality, please pay attention to the following:
 - ① Please do not touch the surface of the screen directly.
 - ② Please do not write or draw on the screen.
 - ③ Do not scratch the screen with sharp objects.
 - ④ Do not use corrosive cleaners to clean the screen.
- After use, please retract the screen into the casing.
- When installing on a wall, ensure that the installation points are on the same level, keeping the screen balanced with the wall.
- Do not pull the sides of the screen by hand. The screen must not be folded.
- It is recommended that the installation and management of the equipment be handled by adults.

NOTICE:

- When retracting the screen into the casing, check the surface of the screen to ensure there are no insects, dust, or foreign objects before rolling it back.

 Warning	If the warning content is ignored and improper operation occurs, it may result in injury or damage to property.	 Mandatory	The screen must be installed in a place with sufficient support to avoid accidents or the screen falling off.
 Prohibited Items	Do not hang anything on the screen or complete wiring outside the screen, as it may cause damage to the product or equipment.	 Mandatory	After use, please retract the screen into the casing to prevent dust and dirt from contaminating the screen.
 Prohibited Items	Do not dismantle the screen or loosen any screws. For repairs or adjustments, please contact our company or an authorized dealer.		

Note

The user should not disassemble or replace parts at will. If there are any faults, please contact the after-sales service department for repairs. Any changes in function or structure will be made without notice, subject to the product.

Operation Guidelines

Control Functions

- A. RF Remote Control
- B. Electronic Limit Setting
- C. Dry Contact Control
- D. RS485/232 Control
- E. 12V Trigger Control

A. RF Remote Control

- Press the Up button: screen retract to set position.
- Press the Stop button: screen will pause.
- Press the Down button: screen will extend to set position.

RF Remote Usage Instructions

1. Operating Frequency: 433.92 MHz
2. Operating Temperature Range: -20°C to +70°C
3. Battery Type: One CR2450 coin-cell battery
4. Battery Replacement: Replace the battery promptly when the remote signal becomes weak to ensure proper operation.

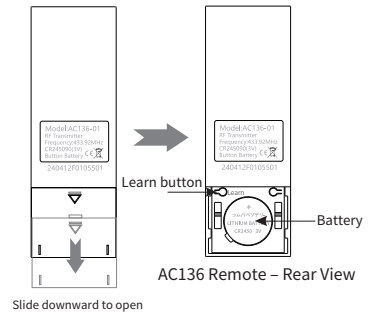
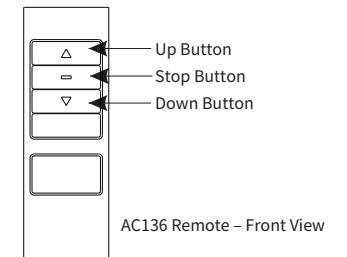

Pairing and Unpairing Instructions

Disconnect the power and wait approximately 10 seconds → Reconnect the power → The screen will jog up and down → Within 10 seconds, press and hold both the Up and Stop buttons simultaneously → The screen jogs again → Pairing complete.

The same procedure applies for unpairing, odd-numbered attempts result in pairing, even-numbered attempts result in unpairing.

B. Electronic Limit Function

Setting the Screen Extension Height (Lower Limit):

Connect the screen to power → Briefly press the "Learn" button on the remote → The screen jogs up and down → Use the Up or Down button to move the screen to the desired height → Press and hold both the Stop and Down buttons simultaneously → The screen jogs again → Lower limit successfully set.

Setting the Screen Retraction Height (Upper Limit):

Connect the screen to power → Briefly press the "Learn" button on the remote → The screen jogs up and down → Use the Up or Down button to move the screen to the desired retraction height → Press and hold both the Up and Stop buttons simultaneously → The screen jogs again → Upper limit successfully set.

Note:

- The upper electronic limit is factory preset to an optimal position and typically does not require adjustment.
- During limit setting mode, the screen operates in jog mode:
 - Short press = step-by-step movement
 - Long press (2 seconds) = continuous movement
- If no operation is performed within 30 seconds, the system will automatically exit setting mode.
- The motor features an intelligent deceleration function. As the screen approaches its fully extended or fully retracted position, the motor will automatically slow down. This may result in slight speed variation near the limit points—this is normal behavior.

2. Insert the locking plate through the holes of the suspension mounting plate, then pass both through the elongated slots of the mounting plate (ensure correct orientation). Secure with M5×10 machine screws to complete the conversion to suspension mounting. Adjust both locking hooks of the mounting plate to the unlocked position (see Fig. 6-7).

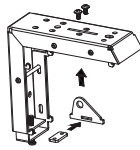

Figures 14

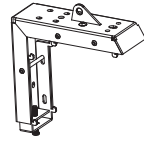

Figures 15

3. ① Raise the screen housing and lock the horizontal hook of the hanging board into the top groove of the housing. ② Push the back of the hanging board and place the vertical hook in the rear groove of the housing. Slide the hanging board left and right to equal the spacing of the hooks, then secure the cross screws to complete the pre-assembling for suspension (Figure 16-17).

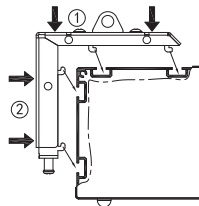

Figures 16

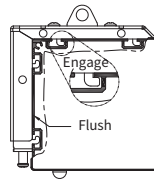

Figures 17

4. Hang the screen on the suspension hook, then check the hook's safety. If needed, take proper precautions to prevent the screen from accidentally sliding off the hook. (As shown in Figure 18)

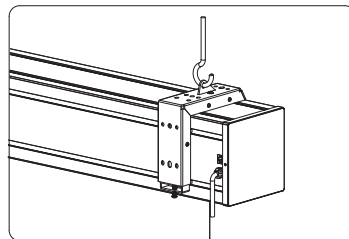

Figures 18

Screen Tension Line Adjustment

Hold the lower rod firmly, take the adjustment key, and align the small end with the hexagonal hole inside the wire-winding device. Gently press the adjustment shaft inward until it rotates freely (tighten by turning clockwise, loosen counterclockwise). Adjust the tension line to the desired tightness, release the pressure, and let the shaft pop back into place to complete the adjustment. (As shown in Figure 19)

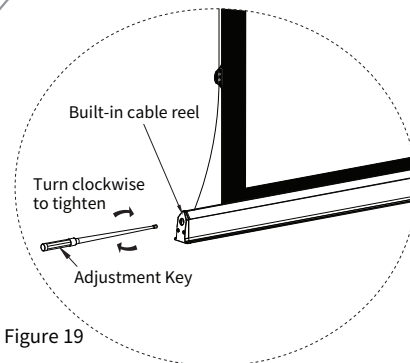
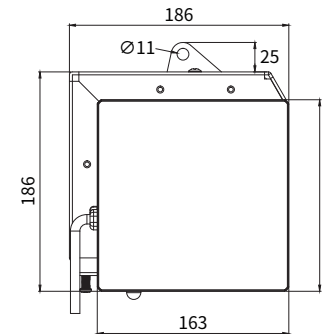
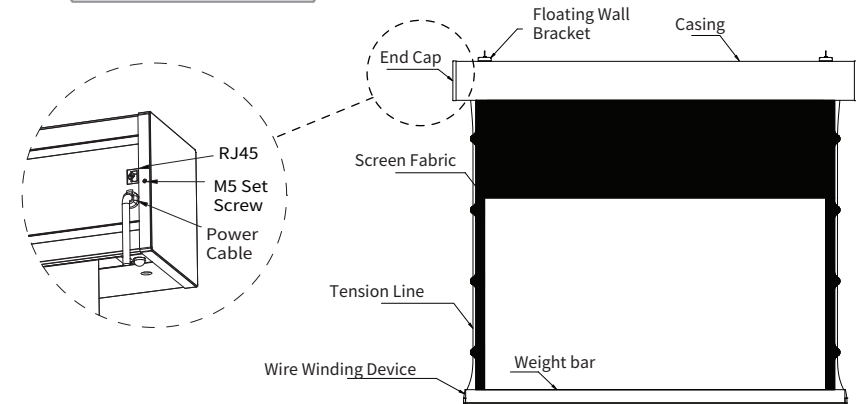
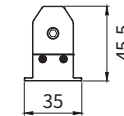

Figure 19

Screen Structure









Side view of the casing

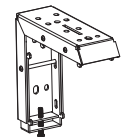

Side view of the weight bar

Accessory Diagram

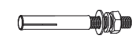
- 
 ■ RF Remote Control(1 piece)
- 
 ■ Floating Wall Bracket (2 pieces)
- 
 ■ Installation Bracket (2 pieces)
- 
 ■ Adjustment Key (1 piece)
- 
 ■ Ø6x50mm Self-tapping Screws and Expansion Glue (6 pieces)
- 
 ■ Ø5x10mm Machine Screws (4 pieces)
- 
 ■ M8×60 Expansion Bolts (4 pcs)
- Instruction Manual (1 piece)

Installation Steps

1. Open the package, check if the necessary parts are complete according to the accessory diagram in the manual, then carefully remove the required parts from the package and place them in the proper location. Follow the instructions below to proceed with the installation.

2. This product can be installed using either a sliding backplate bracket or a suspension backplate bracket. The installation distance can be adjusted by moving the backplate or suspension bracket according to the site requirements. The ideal installation position is to place the bracket as close as possible to both ends of the casing, which helps reduce vibration and noise.

I. Sliding Backplate Bracket Installation Method

1. Based on your needs, choose wall installation or ceiling installation. (Recommendation: If the wall or ceiling is made of wood, use wood screws; if it is made of concrete, use expansion bolts)

2. Install the bracket on the surface corresponding to the back or top of the screen, ensuring that both left and right brackets are aligned horizontally.

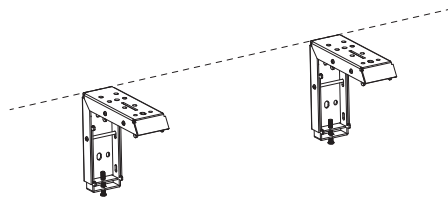

Figures 1

Installation Methods:

a. Installation on Wooden Walls or Ceilings:

Insert four Ø6x50 self-tapping screws through the corresponding holes in the back or top of the mounting frame, and secure them to the wall or ceiling. (As shown in Figures 2-3)

b. Concrete Wall or Ceiling Installation:

Place the mounting plate at the desired installation position. Mark the large hole locations on the mounting plate with a pen. Drill the holes for the expansion anchors, then insert the M8 expansion bolts. Position the mounting plate onto the anchors and tighten the nuts securely to complete the mounting plate installation.

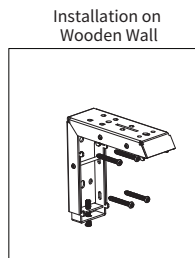

Figures 2

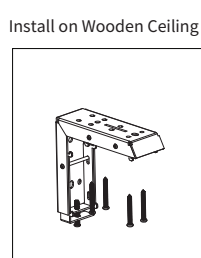

Figures 3

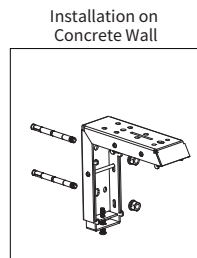

Figures 4

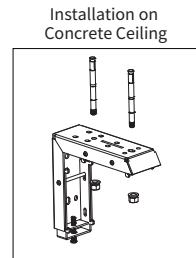

Figures 5

Installation Steps

3. Before installation, loosen the crosshead screw counterclockwise to release the vertical locking hook and slide it downward toward the edge of the elongated slot. Then, slide the horizontal locking block outward to the outer edge. (See Figures 6-7)

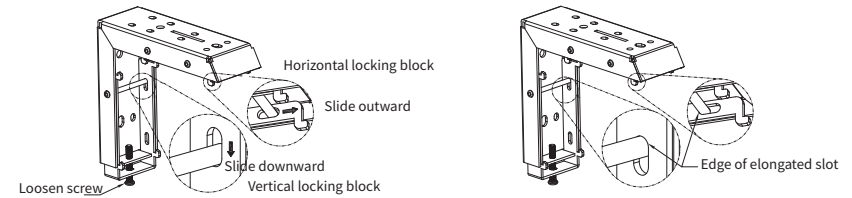

Figures 6

Figures 7

4. Carefully raise the screen housing and align it with the horizontal locking groove on the mounting bracket (see Figure 8). Insert the top of both brackets into the notches on the screen housing until the brackets sit flush with the top panel (see Figure 9). Then, push the screen toward the wall so that the locking hook clicks into the rear groove on the housing. Verify that the screen is fully seated and flush against the mounting surface. (See Figure 10)

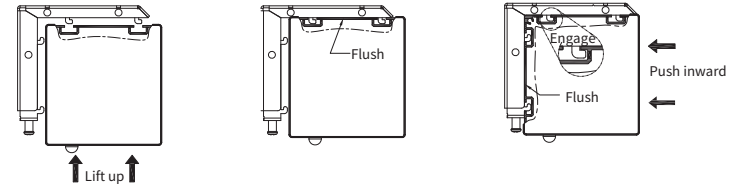

Figures 8

Figures 9

Figures 10

5. Gently press the screen housing, then horizontally adjust the screen to the center of the mounting brackets. Next, tighten the cross-head screws clockwise until the vertical locking hooks on the mounting bracket fully secure the housing, thereby completing the screen installation. (Refer Figures 11-12)

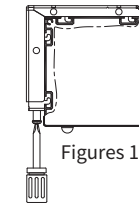

Figures 11

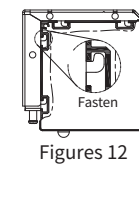

Figures 12

II. Suspension Installation Method

Based on the ceiling material, choose the appropriate expansion screws (not provided) or other installation screws with hooks (not provided).

1. Drill two appropriately sized holes in the ceiling with a drill, ensuring that the line formed by the two holes is parallel to the wall. Insert two expansion screws with hooks (not provided) into these holes. (As shown in Figure 13)

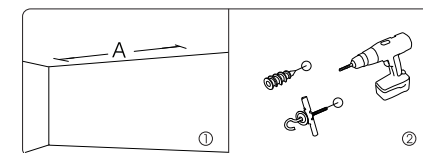

Figures 13