

Parts Included

Before assembling the screen, check to ensure you have all the parts listed in the Parts List. Some screws and parts are pre-installed, and some extras provided.

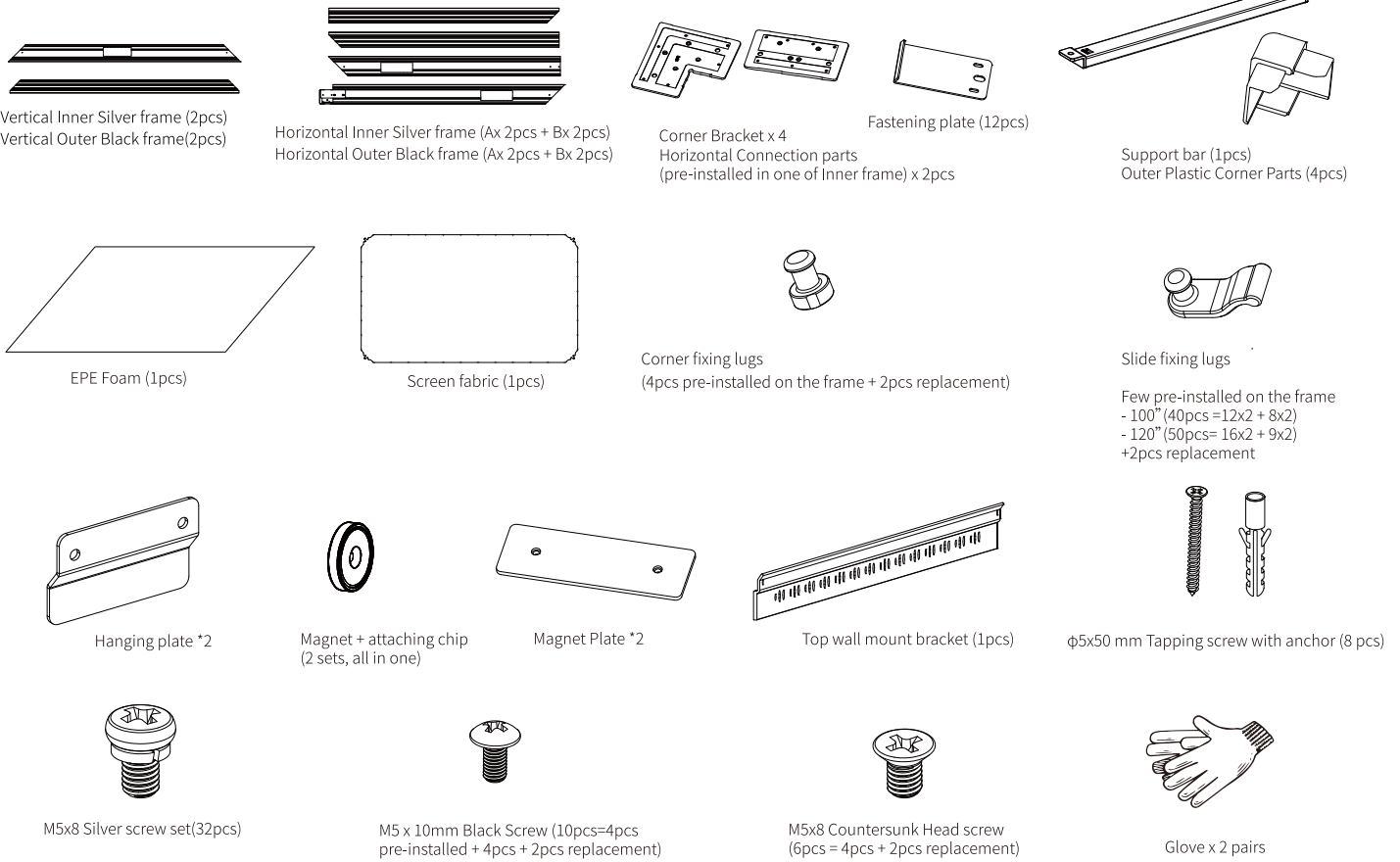

Step 1 Inner Silver Frame Assembly

1

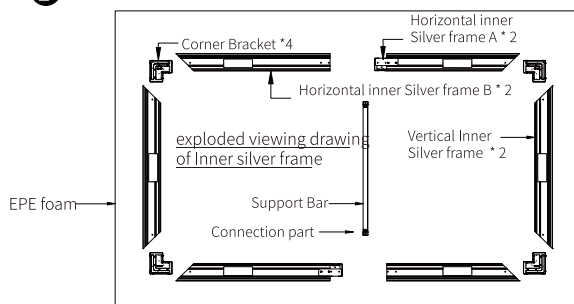

Check the required parts:

- Place the included EPE foam on flat ground.
- Then Wear the glove and lay all the silver frame and hardware parts on the EPE foam to ensure you have all the required pieces. (see the exploded view drawing of the frame above)

2

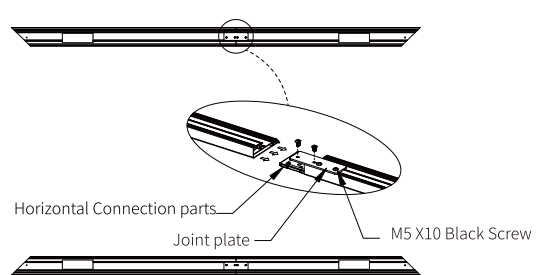

Connect the horizontal frame:

- Loosen the 4 pcs black M5*10 screws which have been pre-installed on the connection parts, then insert it to the horizontal frame B and align with the holes on both sides, finally securely fasten with the same black M5*10 screw.

3

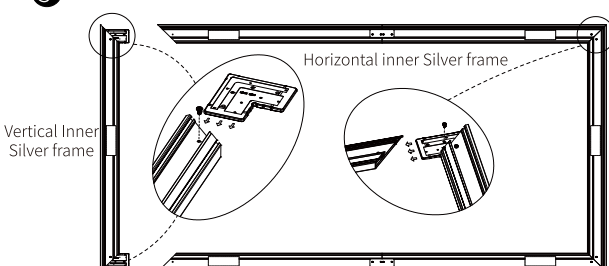

Connect the vertical inner silver frame :

- Connect the corner bracket to both ends of the vertical inner frame. Then connect the vertical frame sections to the horizontal frame sections. And align with the holes correctly, then securely fasten with the silver M5*8 screws.

4

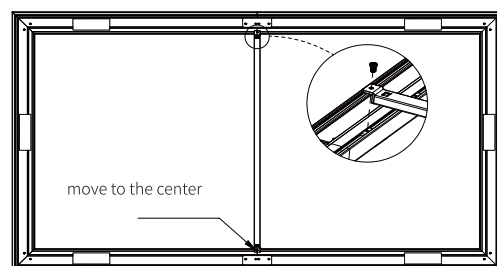

Placing the support bar :

- Move the pre-installed nut to the center of the connection plate, then place the support and securely fasten it with the white M5*8 screws.

Step 2 Screen fabric assembly

1

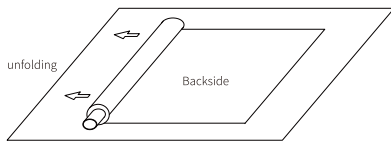

Unfolding the fabric:

- Clean the EPE foam and ensure flat surface with no foreign particles.
- Lay the fabric with the backside on the Top.
- Remove the interleaving pad on the bottom of the fabric designed to prevent transit damage.

3

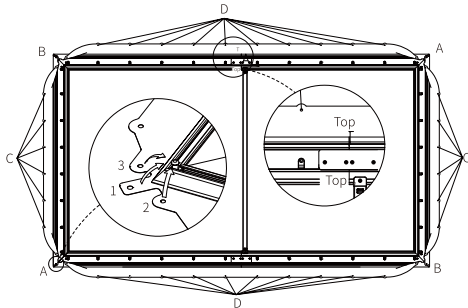

Pull fabric eyelets over the fixing lugs:

- Two people should pull the fabric eyelets over the fixing lugs at both ends, in the order of AA-BB-CC-DD.
- Attach the corner in the order 1-2-3. See the diagram above.
- Two people mount the fabric in sync on both ends and gently lift the frame a bit when mounting the fabric to ensure fabric flatness and alignment with the frame.

2

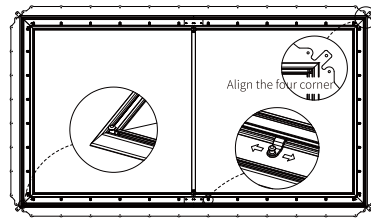

Place the assembled frame on the screen fabric:

- Place the assembled frame on the top of the screen fabric in the marked areas (Top to Top) and ensure the backside of the screen fabric is facing up.
- Align the screen fabric corner with the frame corner shown in the diagram above.
- Don't allow the angled edge of the frame to come in direct contact with the screen fabric.
- Tear out the protection tape on the inner frame, then align the pre-installed fixing lugs and the eyelets provided on the fabric. Also, align the pre-installed corner fixing lug to the corner center.

4

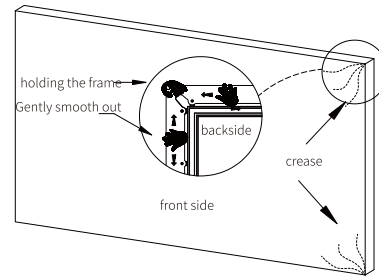

Checking whether the fabric viewing surface is flat:

- Wear the gloves on and ensure they are clean, then pull and smooth out the material using your hand from the center to the corners, creating an even surface.

Step 3 Outer black frame assembly

1

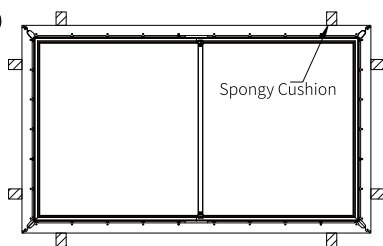

- Before assembling the outer black frame, place the sponge cushion under the assembled screen as per the diagram above.

2

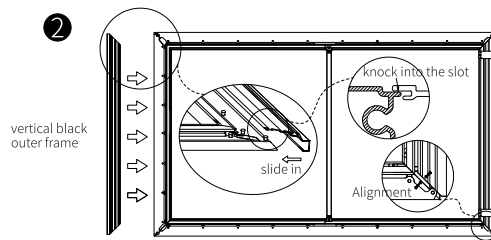

Place the outer vertical black frame:

- Slide the frame to the positioned slot properly. See the diagram above.

3

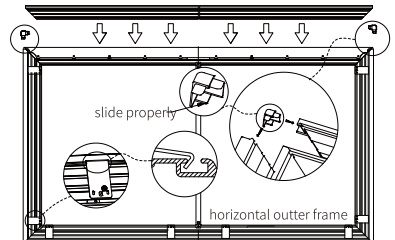

Place the outer horizontal black frame and outer plastic corner parts:

- Slide the horizontal frame into the positioned lot, then install the outer corner parts. Finally, fasten the plate with M5*8 screw. See the diagram above.

Step 4 Wall mount installation

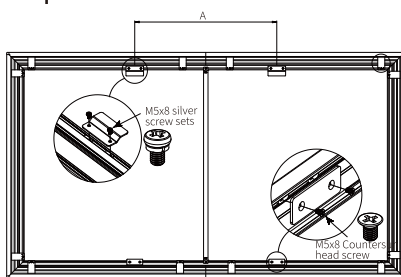

- Ins tall the hanging plate on the top of the frame and fasten it with the required M5x 8 screw sets. See the diagram.
- Ins tall the magnet plate on the bottom of the frame and fasten it with the required M5x8 countersunk head screw. See the diagram.

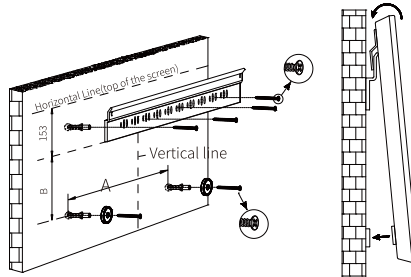

Mount spec (16:9)	100"	120"
A(mm)	1100	1300
B(mm)	1030	1280

- According to the projector type and room, please measure the overall width and height of the frame and drill holes for the top mount bracket, and secure the bracket with $\phi 5 \times 50$ mm Tapping screw sets. Please check measurements in the diagram.
- Drill holes for the magnet plate, all the distances (A and B) are shown on the above spec sheet.
- Then hang the screen on the wall (see the diagram), in the order of top mount slot-in, then attach the bottom frame to the magnet.
- We strongly recommend two people handle this when moving the screen, and please wear gloves and ensure not to touch the screen fabric, to prevent fabric scratches and damage.

PLEASE READ IF SCREEN IS IMPERFECT:

IF THE SCREEN HAS CREASES, WRINKLES OR ANY DEFORMITIES ON THE SURFACE
PLEASE CHECK IF YOUR FABRIC WAS CENTERED 100%
BEFORE INSTALLING THE FRAME

IF THE FABRIC STITCHING APPEARS TO BE SHOWING INSTEAD OF HIDING UNDERNEATH THE FRAME PLEASE CHECK IF THE FRAME WAS ASSEMBLED PROPERLY

IF THERE IS ANY OTHER ISSUES WITH THE FRAME OR SURFACE PLEASE CONTACT YOUR DEALER IMMEDIATELY AND GRANDVIEW WILL ASSIST YOU AS SOON AS POSSIBLE.

MOST OF THE ISSUES AND DEFECTS WE HAVE EXPERIENCED WITH THESE SCREENS ARE INSTALLATION/USER ERROR