

Grandview[®]

Manual Instruction for Table-Top Screen

U-WORK

Grandview[®]



st ylpCRt ftu tfdu tRcipu Rf.tW ulT Wpu fW-Ru UTcrU cpuCRfW itRuKUc-puKiUWf
Lb.gu z,hn y n y uuuf gu z,hn y hnllyl
ebGTUcbgu rWd Ub T rbbW t
aaaaaaaaaaaaa b b b



Model: PT-Uxx

Thank you for purchasing a Grandview projection screen.
Before use, please read instructions carefully. After installation, keep instructions for future reference.

Description

Illustration

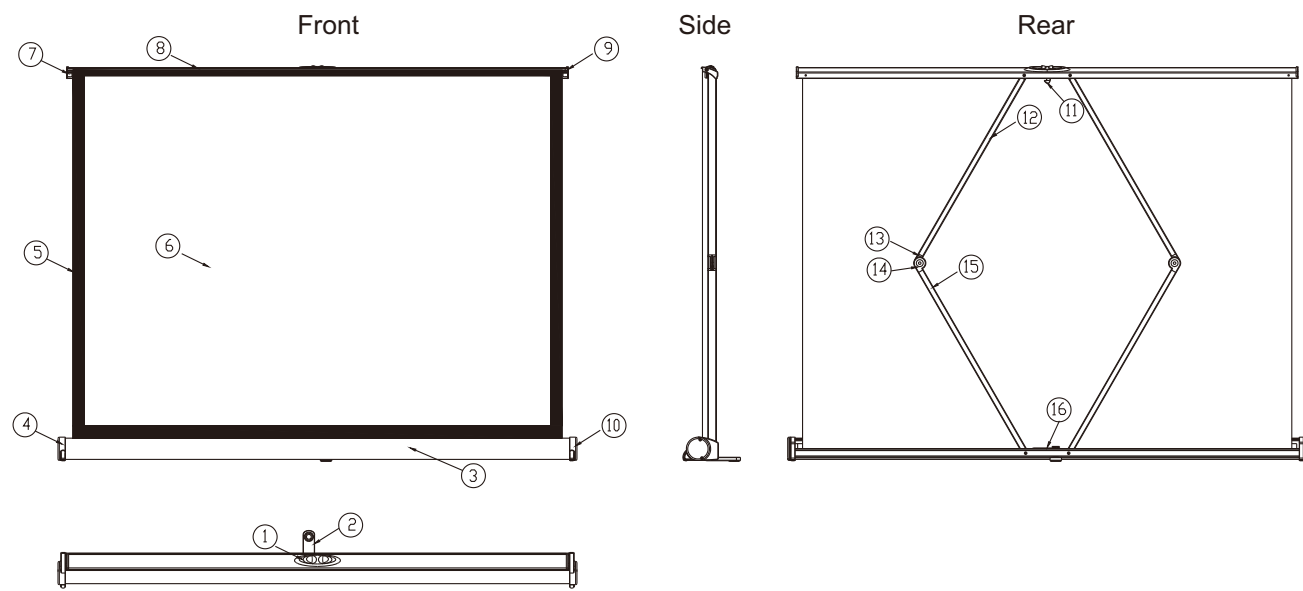

Part name

①	Opener	⑨	End Cap
②	Foot	⑩	Right End Cap
③	Casing	⑪	Conjugation
④	Left End Cap	⑫	Support Lever
⑤	Black Border	⑬	Joint
⑥	Fabric	⑭	Joint
⑦	End Cap	⑮	Support Lever
⑧	Cover	⑯	Locker

Accessories

Bag (1pcs)



Manual Instruction (1psc)



Note

The surface of screen is processed to achieve good performance of the reflector. Any damage of surface will influence projection effects so please use this product in right way.

Caution

- Please do not shake the screen by hand.

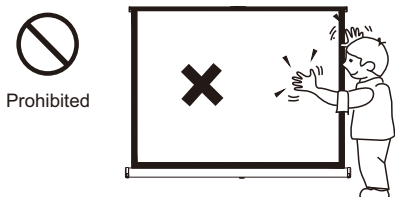

- Please do not use any cloth with water, volatile oil and corrosive cleaning agents to clean the screen, because they will make the surface metamorphosis and paint off.

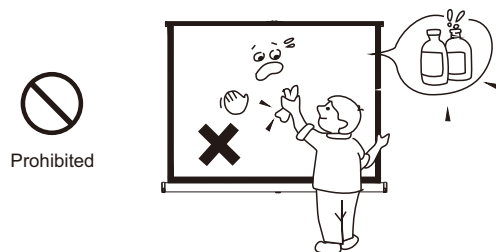

- Please do not make any marks on screen surface.

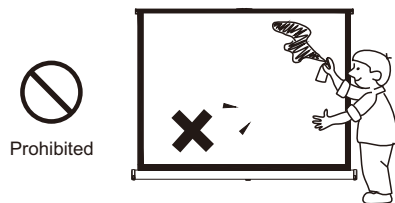

- Please do not pull the screen strongly that it will cause the risk of damage.

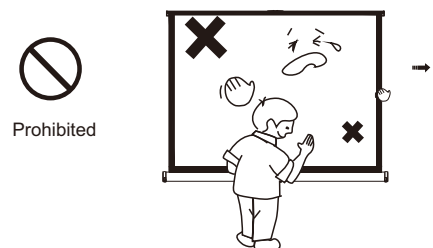

Maintenance

- Any stains on the casing, please use dry-cloth to clean softly. If too serious, please use soft-cloth with water-diluted neutral detergent to clean.



- Please use a brush to clean the dust of screen surface softly.

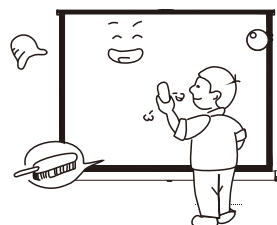

Location Caution

- Please keep the screen far away from sunshine, dust and wet. Avoid using the screen in strong wind.

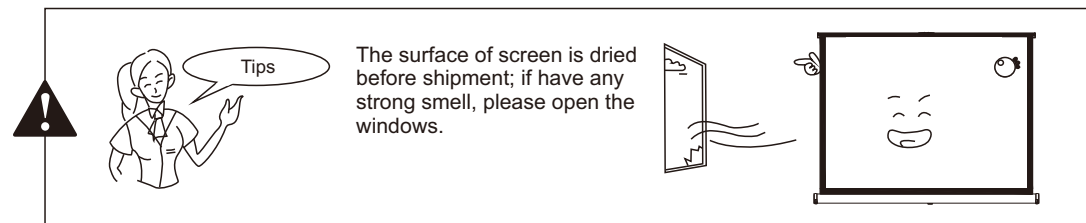

Caution

- Please contact your local dealer for repairing and replacing. Please contact us if you have any questions. Avoid taking apart the fixture yourself.



Specifications

Format	Model	Specification (In)	Viewing area		Screen dimension		Net weight (kg)
			W (mm)	H (mm)	L (mm)	A (mm)	
4:3	PT-U-32	32	650	488	742	566	1.13
4:3	PT-U-40	40	813	610	905	688	1.46

Note: Sizes and specifications are subject to change at any time. Refer to real product for exact data.
The tolerance for L is ± 5 mm.

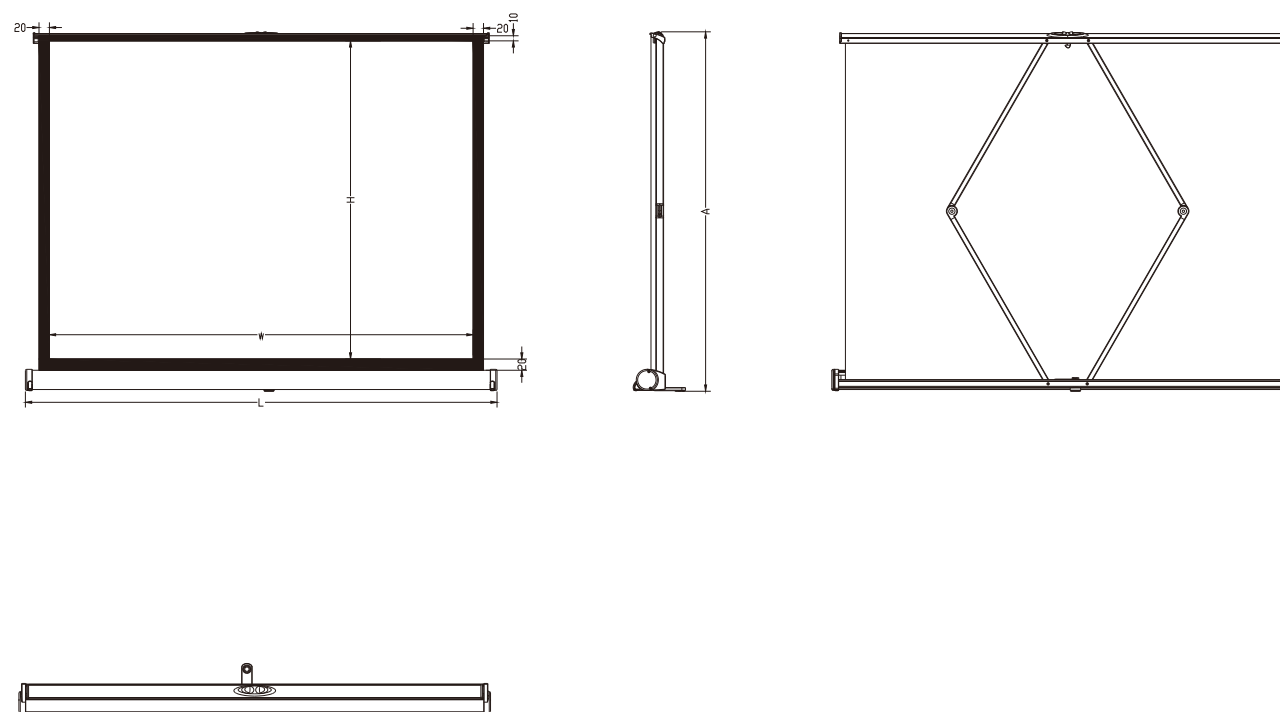

Expanding

1. Stay the screen on suitable position and the screen faces to projector, and the set up the foot of screen (figure 1, 2 and 3)

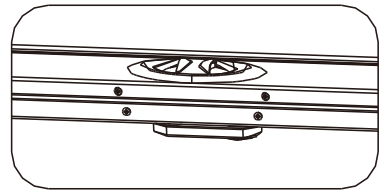

Figure 1

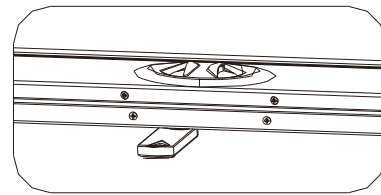

Figure 3

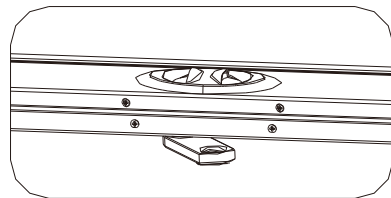

Figure 2

2. According to figure 2-1, use fingers to hold the opener, and then pull the screen up to your desired position slowly (figure 2-2)

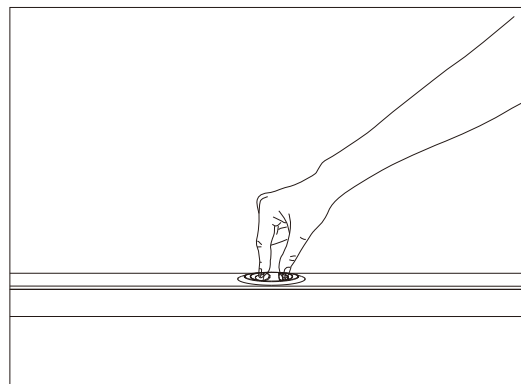

Figure 2-1

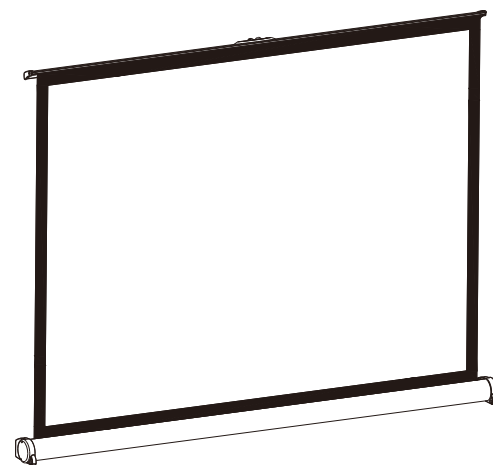

Figure 2-2

Retracting

1. According to figure 3-1 and 3-2, following the steps to close the screen.

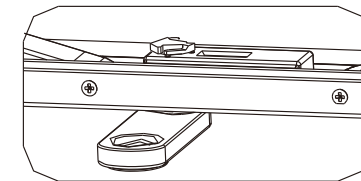

Figure 3-1

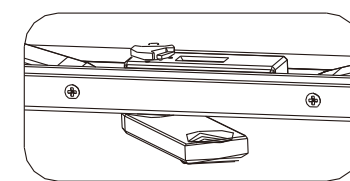

Figure 3-2

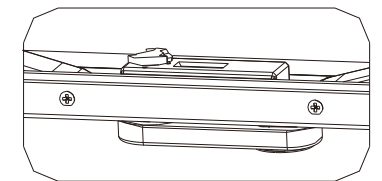

Figure 3-3

2. According to figure 4-1, using fingers to hold the opener and push the screen down (figure 4-2). Please ensure that the cover is locked to the casing that the retracting is completed (figure 4-4).

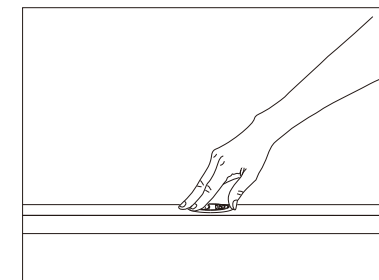

Figure 4-1

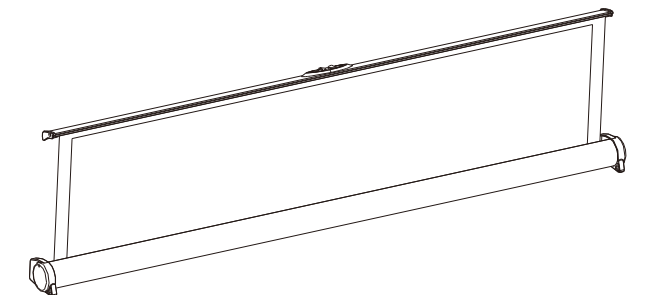

Figure 4-2

Note: Avoid hurting fingers while running those operations (figure 4-3).

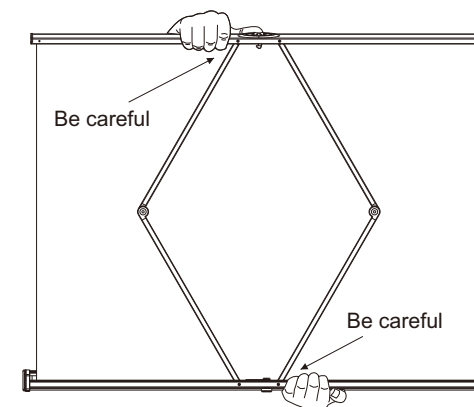

Figure 4-3

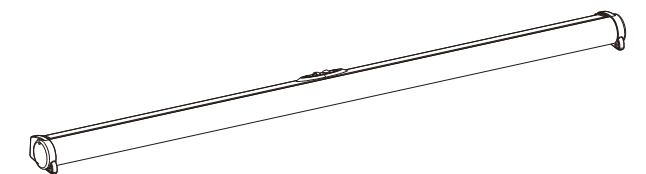

Figure 4-4