

Note :

- When connecting to Rs232 or Rs485, if there is any motion that cannot be controlled by the screen, please adjust the screen, please adjust the two control lines;
- Wiring loop resistance is less than 20Ω;
- Do not run in parallel with strong interference sources;
- 232 port setting: 2400, n, 8, 1 A data string should be sent twice consecutively.

Wireless control :

- Press the up button, the screen will rise.
- Press the stop button, the screen stop.
- Press the down button, the screen down.

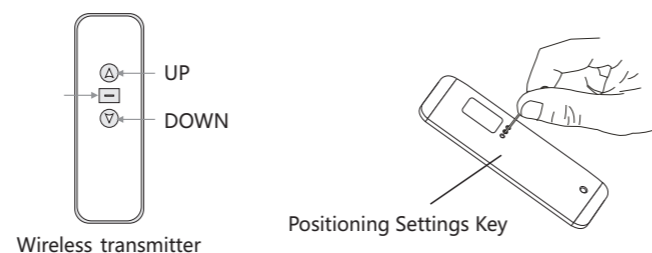

Code pairing / deleting (factory pairing is successful):

Long press the cycle button for 3 seconds, the screen is jogged once to enter the code-matching state; within 10 seconds, the remote control up and stop buttons are also pressed, and the screen is jogged again to complete the code-matching; the code deletion is the same as the code-matching operation, odd times The operation is code pairing; even code deletion.

Intelligent electronic stroke positioning (this product can set the up and down stroke of the fabric through the remote control)

Operation method:

Upward stroke setting: Positioning setting key (light on) → Up key → Up and down remote control to the desired position → Stop → Positioning setting key (light off) → Upward travel record success

Downstroke setting: Positioning setting key (light on) → Down arrow key → Remote control up and down to the desired position → Stop → Positioning setting key (light off) → Downstroke recorded successfully

Adjusting method of fabric retracting (upper limit) and unfolding (lower limit):

If it is really necessary to adjust the limit height due to the installation environment or site limitation, you can use the motor positioning adjustment key to rotate the knob on the motor limiter; the limiter adjustment knob is located in the 12 round hole next to the power cord outlet.

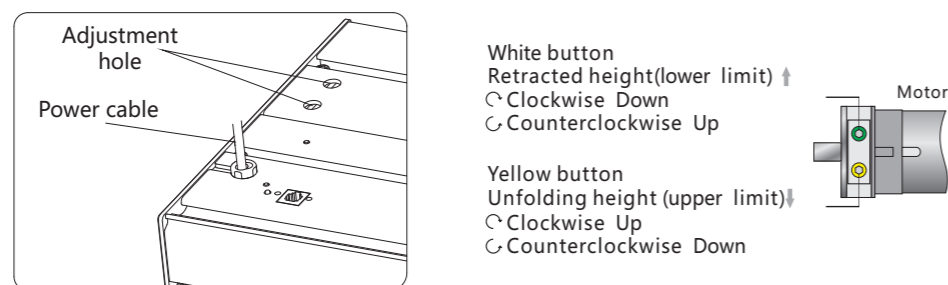

Pay attention:

To confirm the accuracy and security of the screen position, It is necessary to control the screen up and down after adjusting every half turn of the button, Check if the position is moving correctly;

Be careful when adjusting the screen retracted height. Excessive adjustment will cause the lower rod to snap into the casing and cause serious damage to the screen or the lower rod falling;

Be careful when adjusting the unfolding height of the screen. Always keep the fabric 1.5 turns or more around the tube to ensure that the fabric does not fall;

Electrical parameters: Voltage Ac220 ~ 230V 50 /60Hz , Current 1.5A;

Wireless remote control (F): voltage 3V, using battery CR2032X2, transmission frequency; 868MHZ, effective control distance of about 15 meters;

Guangzhou Grandview Creative Technology Co., Ltd

Add: No.1 Building of No.43 South International Trade Avenue, HualongTown,

Panyu District, Guangzhou China.

Tel: +8620-8489-9499 Fax: +8620-8480-5299

Web: www.grandviewscreen.com



Grandview

Large Stage MBII Installation Manual

Model:LS-MBFxxxII(xGxx)

Intelligent RF control with external motor

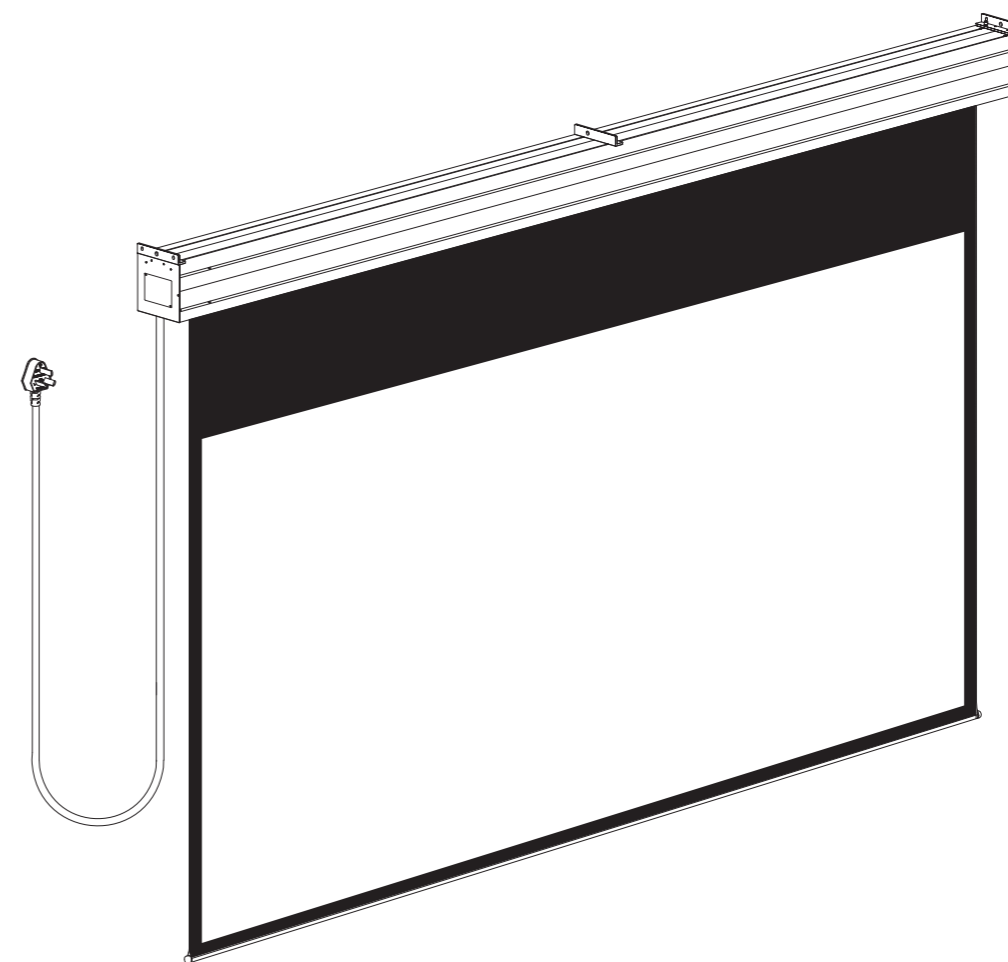

Reminders

- Thank you for purchasing Grandview products. Please read the instructions carefully before installation and use, and collect it after reading for future use;
- This product must be installed by a qualified professional after the feasibility assessment of the environment, electricity, structure, etc.;
- Do not disassemble or replace the original spare parts at will: If there is any fault, please contact the after-sales service department.

Screen structure

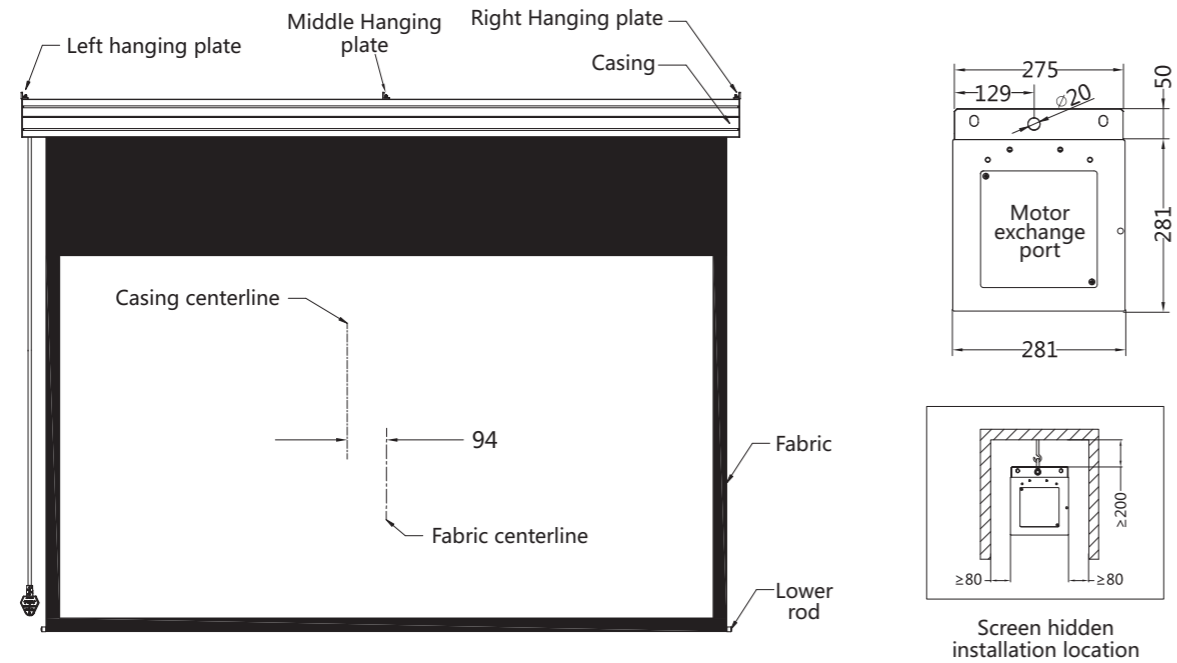

Accessories

- Motorized adjust tool (3)



- Shackle (3)



- Warranty Card (1)

- Instruction manual (1)

- Remote control (1)

Installation method and precautions

Note that due to structural reasons, the position of the fabric is not at the center of the screen. It's offset on the right by about 94mm; This should be considered when determining the location of the mounting holes; It is also recommended to keep a distance of 1 meter on the side of the screen power cord for future maintenance.

Suspension installation

Measure the horizontal spacing of the hanging plate and the length of the product to determine the installation position of the screen, and install three stable hooks on the solid concrete ceiling. Recommended hook type is adjustable.

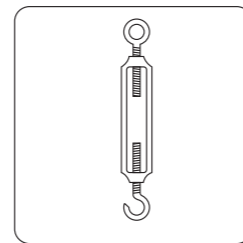
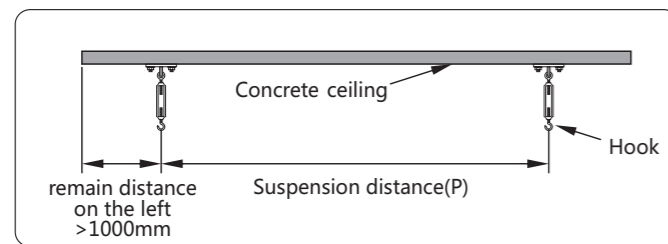

Hook the hook on the shackle of the left, middle and right hanging plate, adjust the length of the hook to the screen level, and complete the suspension installation.

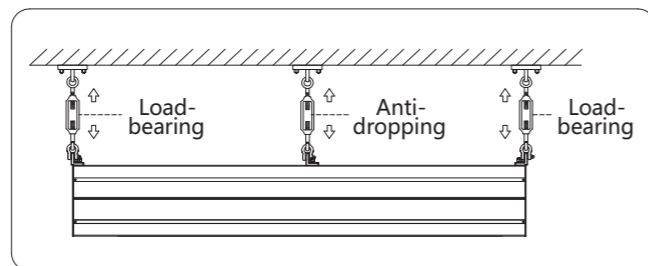
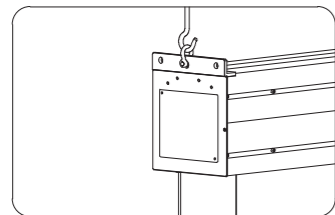

Screw rod installation

Note: The default factory setting of this product is suspension installation. If the customer needs screw rod installation, the method of the hanging plate can be converted!

Converting the hanging plate method: Remove the M10 screws and 8 nuts on the left and right hanging plate, take out the hanging plate and turnover to the corresponding end caps and fasten with screw.

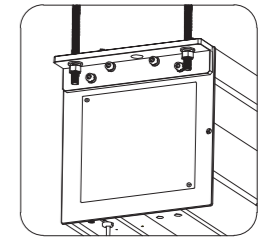
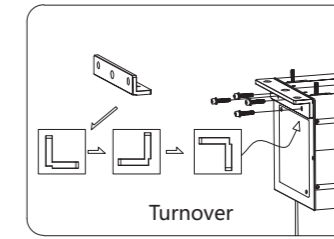
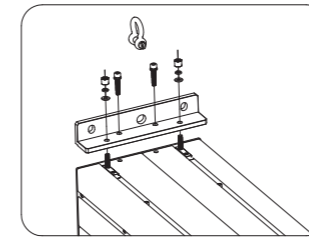

Screw rod installation

Measure the spacing of the four oblong holes on the left and right hanging plate respectively. Install the M12 screw rod directly above the corresponding hole to connect the left and right hanging plate. Install an adjustable hook at the top of the screen to connect the middle hanging plate.

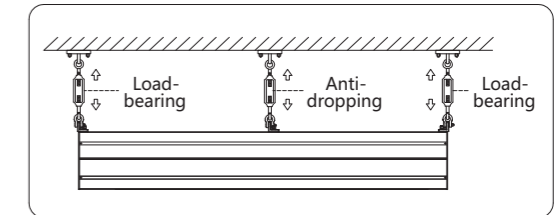

Screen control function description

Intelligent electric screen has 4 control methods:

- A Manual control (cycle button)
- B Wireless control
- C Dry contact control
- D Rs485 or Rs232 control

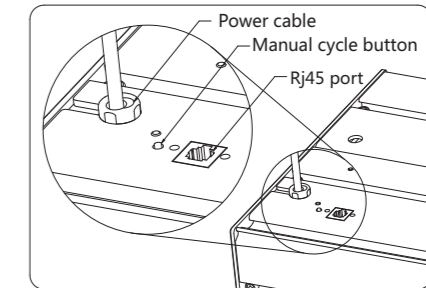

Manual control

The manual control button is on the left end of the screen casing (near the interface). This button is a circular control button.

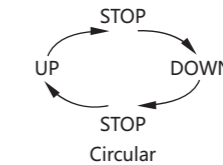

Dry contact / Rs485 / Rs232 control

Crystal head definition

Connection port line number	1	2	3	4	5	6	7	8
function	RS485-B RS232-GND	RS485-A RS232-TXD	stop	up	down			Public line

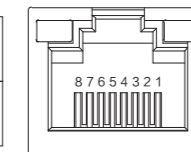

Rs485 / Rs232 port settings

- Data bits : 8
- Start bits : 1
- Stop bits : 1
- Baud rate : 2400

Hex Control Code

- UP : FFFFFFFE
- STOP : FFFFFFFC
- DOWN : FFFFFFFE
- Learn address code instructions FFXXXXXAA
- Some central controls need to set the address code FFFFFFFEA

